

6M OCTOGONAL

Model : PLG6M
HOT DIP GALVANIZED POLE

Without Cross Arm

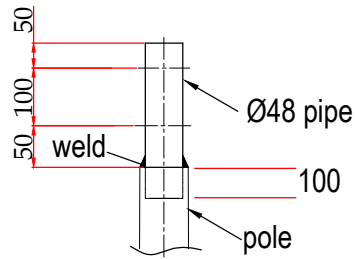
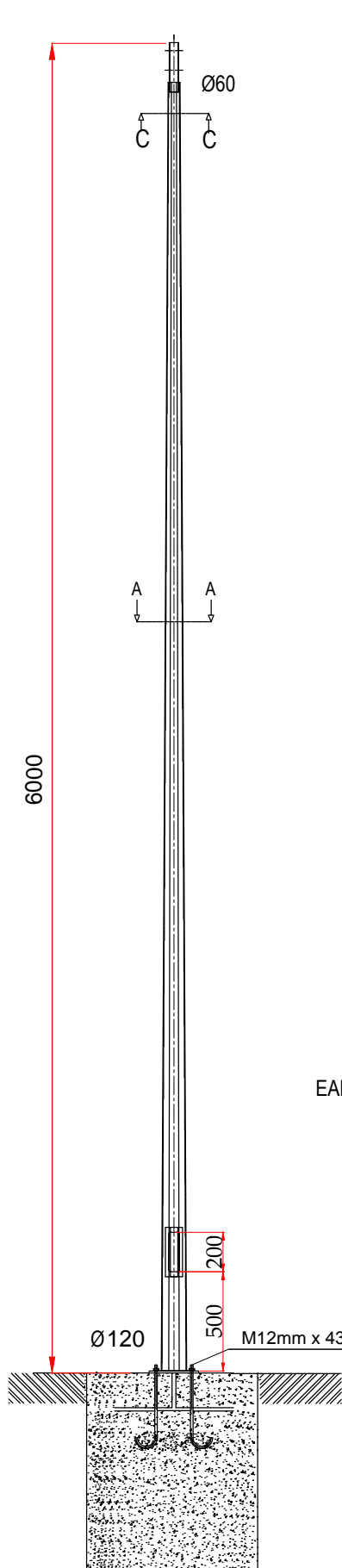

C-C Section

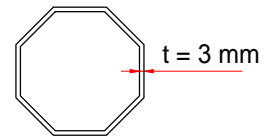

A-A Section

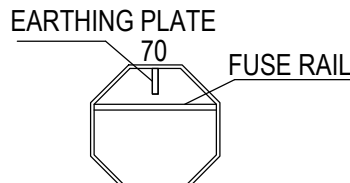

B-B Section

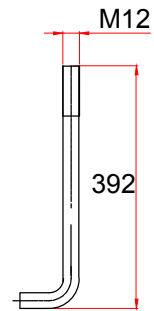

4 X M12 x 432 Anchor Bolts

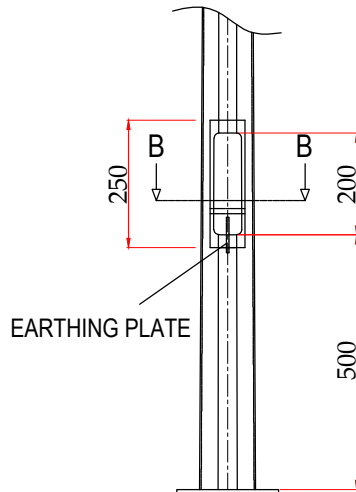

FUSE DETAIL

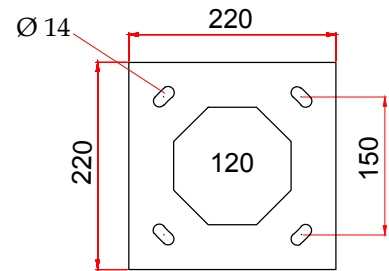

BASE PLATE
8mm x 220 x 220

NOTA: TOTI STALPII SE POT PERSONALIZA IN
FUNCTIE DE CERINTELE PROIECTULUI

Plate Standard : EN 10025
Production Standard : EN 40-5
Galvanizing Standard : EN 1461

URBIO PALAGIO SRL

Str 1 Decembrie, nr 14, Selimbar, Jud Sibiu

ST-O.6M. Model:PLG6M

without Cross Arm

Steel : S235 S235JR (ST37)

www.palagio.ro

Rev : 1