

vizULO

Eagle





Ventilation cable gland

Pressure equalisation. It ensures high air flow rates as well as high water protection capacity

Glass

Flat glass. Glass is fixed to die-cast aluminium frame and can easily be replaced

LED module

High quality LED's with optimal thermal resistance and energy consumption characteristic, for high lumen output and long expected life time. Color temperature available: 2700 K, 3000 K, 4000 K

(1800 K, 2200 K, 3500 K, 5000 K, 5700 K, 6500 K available on customer request)

Sockets

Zhaga and NEMA sockets compatible

Module temperature control

The LED driver will start reducing the light output when the LED's approach critical temperature. The temperature is measured via a sensor placed on the PCB

(function available on customer request)

Body

Die-cast aluminium

Lighting protection

Built-in surge protection 10 kV

Light regulation

EAGLE drivers offer integrated midnight dimming and network-controlled 1 - 10 V, DALI and DMX protocols

Protection

IP66 for the complete luminaire



Midnight dimming

Midnight dimming provides multi-stage night-time power reduction based on an internal timer referenced to the power on/off time. There is no need for an external control infrastructure. The unit automatically performs a dimming profile based on the predefined scheduled reference to the midpoint, which is calculated based on the power on/off times.

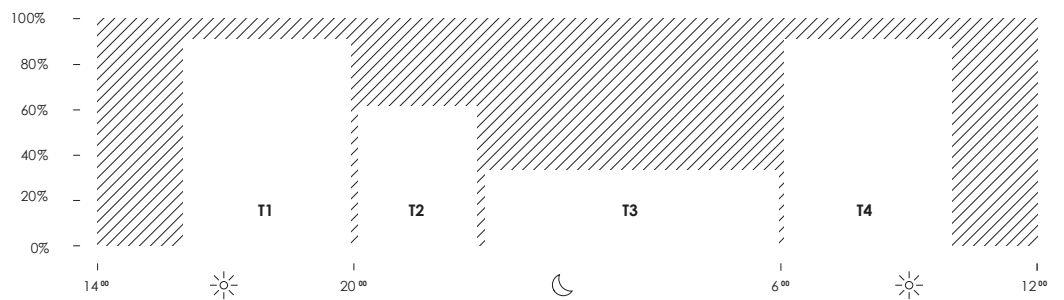

Application

▾ Football fields



▾ Swimming pools

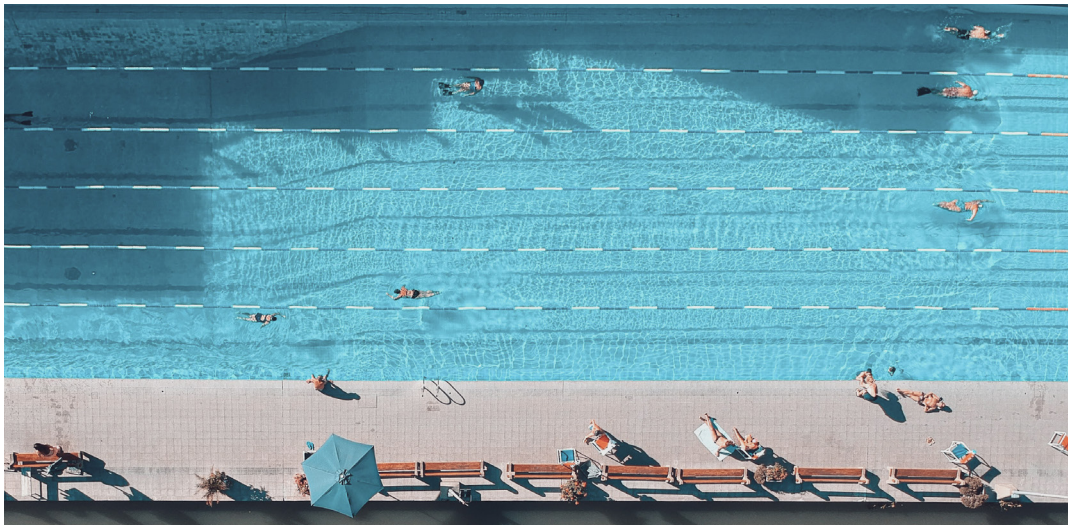

▾ Tennis courts

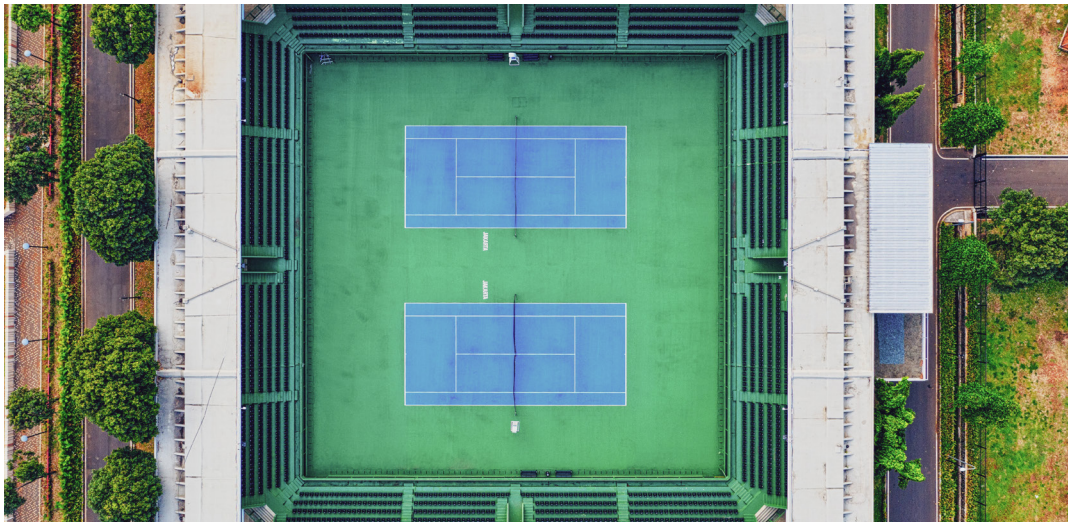

Ports

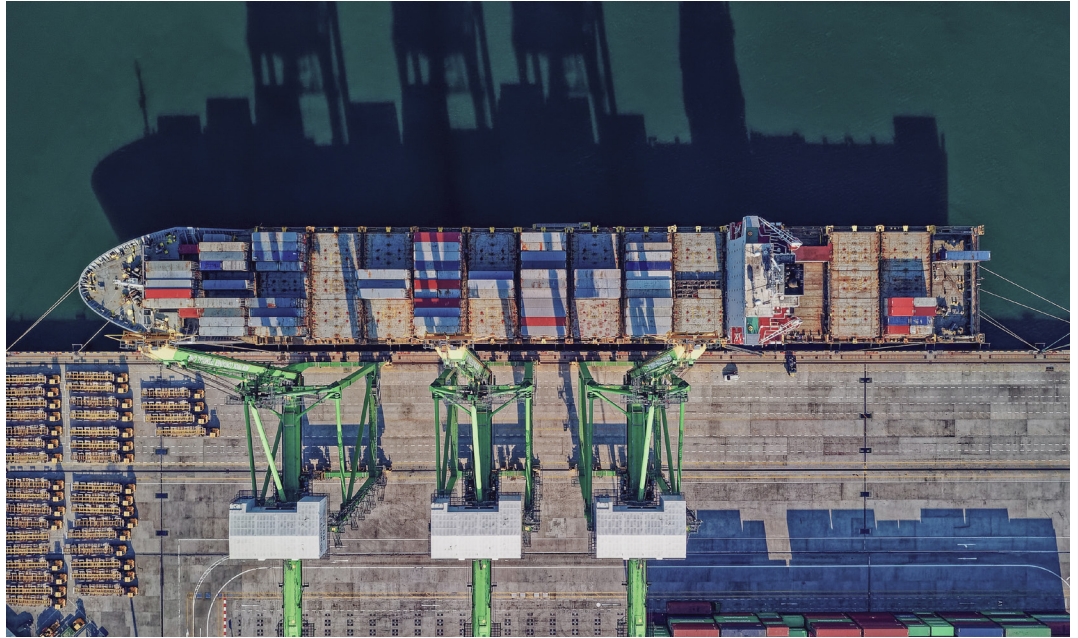

Industrial areas



Stadiums

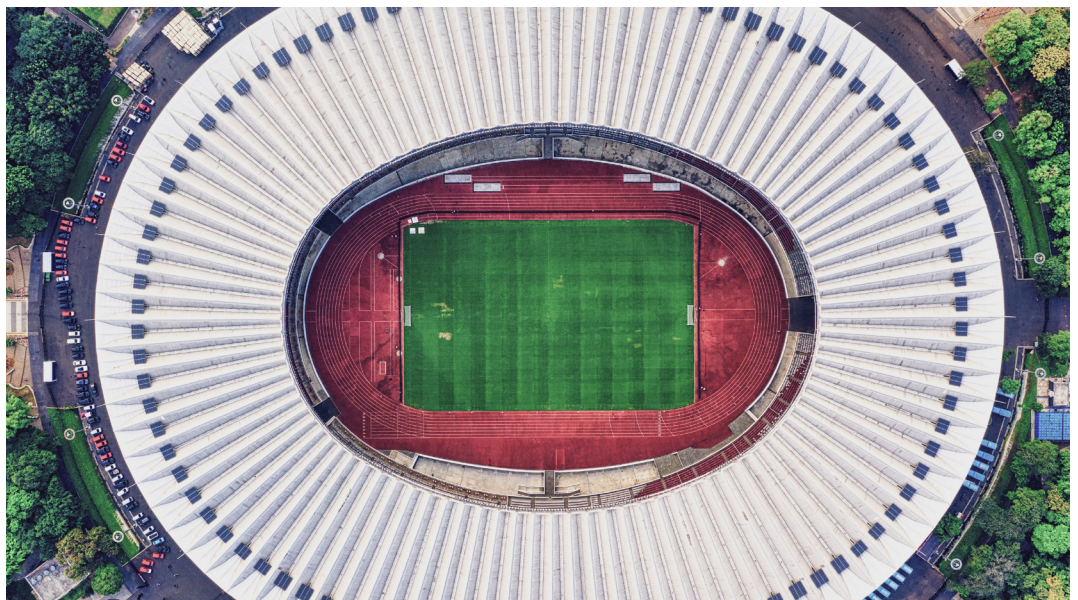

Eagle 3 heads

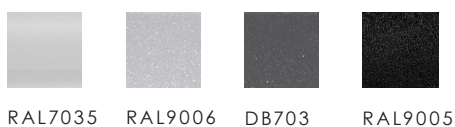
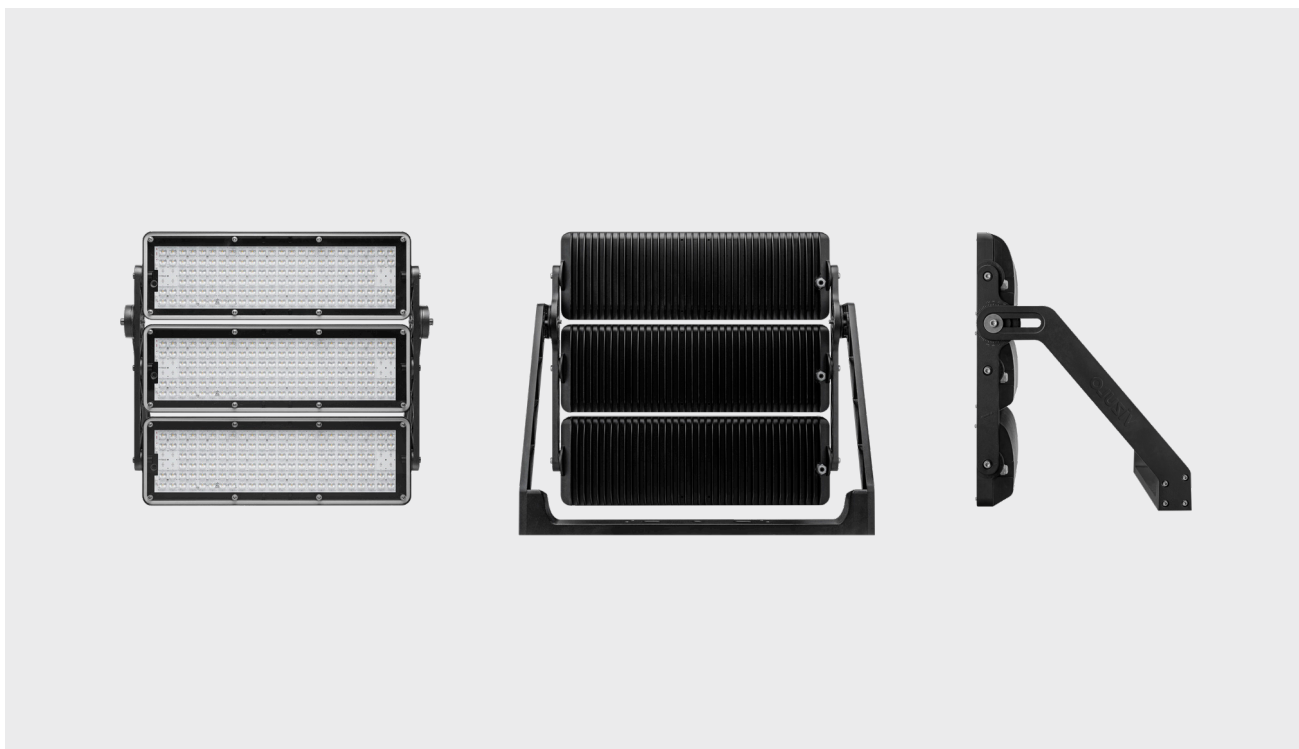

Other colors
available on request

Dimensions with DELTA driver

Standard

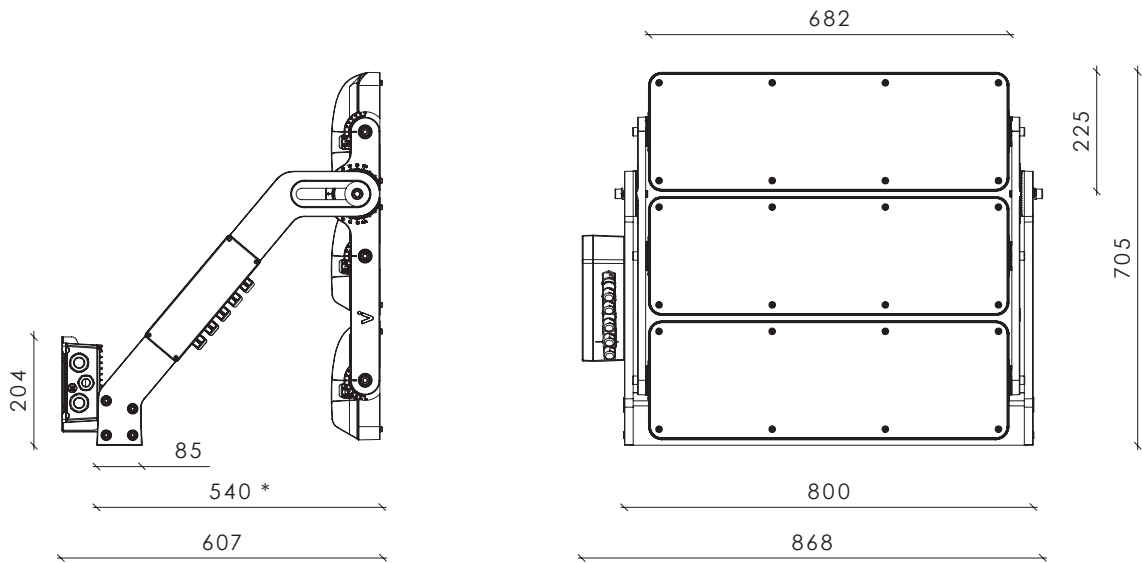

Premium

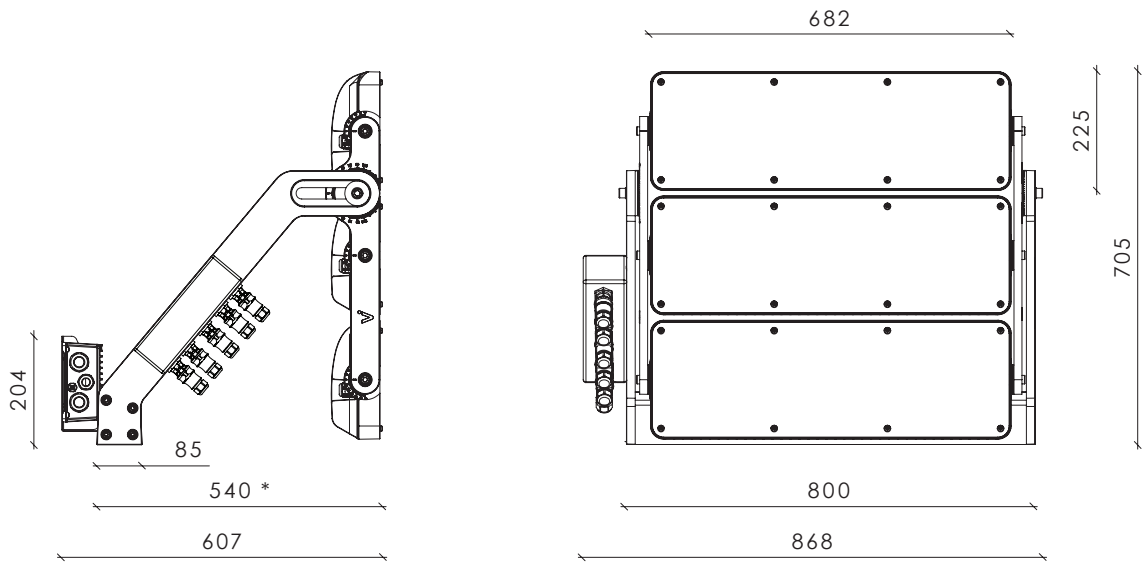

* Dimensions valid for EAGLE Split version (with external driver)

Mounting bracket

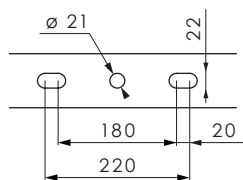

Wind load

$$SCx = 0.19 \text{ m}^2$$

Maximal wind load with driver box depending to the angle relative to the ground

	0°	15°	30°	45°	60°	75°	90°
SCx, m ²	0.19	0.28	0.37	0.45	0.50	0.52	0.53

Technical information

3 heads
360 / 432 LED



V	198 - 264 / 110 - 277 ¹⁾
Hz	50 - 60
W	765 - 1580 360 LED version 765 - 1800 432 LED version
lm	Up to 228 472 ²⁾
lm/W	Up to 157
K	4000 / 5000 / 5700 ³⁾
°C	-40 to +50
CRI	>70 / >80 / >90 ³⁾

Body:	Die-cast aluminium
Dimming:	DALI / 1 - 10 V / DMX / Midnight dimming / Step dimming / Mains dimming
TLCI:	>90 ⁴⁾
Initial chromaticity:	MacAdam 5
Lifetime:	Up to 100 000 h (L98B10) at Ta = 25 °C*
Warranty:	5 years
Installation:	On bracket / wall / ceiling
Socket:	NEMA / Top Zhaga
Intelligent Control:	Stand-alone / Group / CMS
Sensor:	Daylight
Surge protection:	10 kV
Corrosion protection:	Up to C5
Neto weight:	Up to 33.1 kg

¹⁾ Maximum operating voltage, ENEC certificate voltage 220 - 240 V, UL certificate voltage 110 - 277 V

²⁾ Lumen output indicated at CRI > 70

³⁾ 1800 / 2200 / 2700 / 3000 / 3500 / 6500 K available on request along with other not listed CRI and CCT

⁴⁾ For CRI > 90 and CCT 5000, 5700 K

⁵⁾ Ball proof: tested according to DIN 57710-13

*This value is only informative and may change according to selected article. LED Lifetime is strongly depending from LEDs current and junction temperature – increase in LED current and luminaire power lead to increase of junction temperature and as consequence lifetime decrease. Thus, luminaire models with lower power, lower current (and lower junction temperature) will have higher lifetime than standard models. And high power and high current luminaire models may have negative lifetime deviation comparing to standard models. To receive precise value please contact VIZULO export representatives.

Technical parameters for final product can differ from typical data by 7% due to special conditions of LED manufacturing processes.

ECO

* Data for L01 optic.

Check VIZULO members section for additional information

4000 K | CRI 70

Number of LED's	360			432		
	Nominal current, mA	255	540	690	300	460
Power, W	765	1200	1580	765	1200	1800
Luminous Flux, lm	116375	165120	201225	120221	171815	228472
Efficacy, lm/W	152	138	127	157	143	127
Power factor, PF	Up to 0.99			Up to 0.98		

Luminaire efficacy	2700 K	765 - 1800 W	108997 - 214004 lm	119 - 147 lm/W
	3000 K	765 - 1800 W	113465 - 222744 lm	124 - 153 lm/W
	5000 K	765 - 1800 W	116375 - 228472 lm	127 - 157 lm/W
	5700 K	765 - 1800 W	116375 - 228472 lm	127 - 157 lm/W

Model name principles

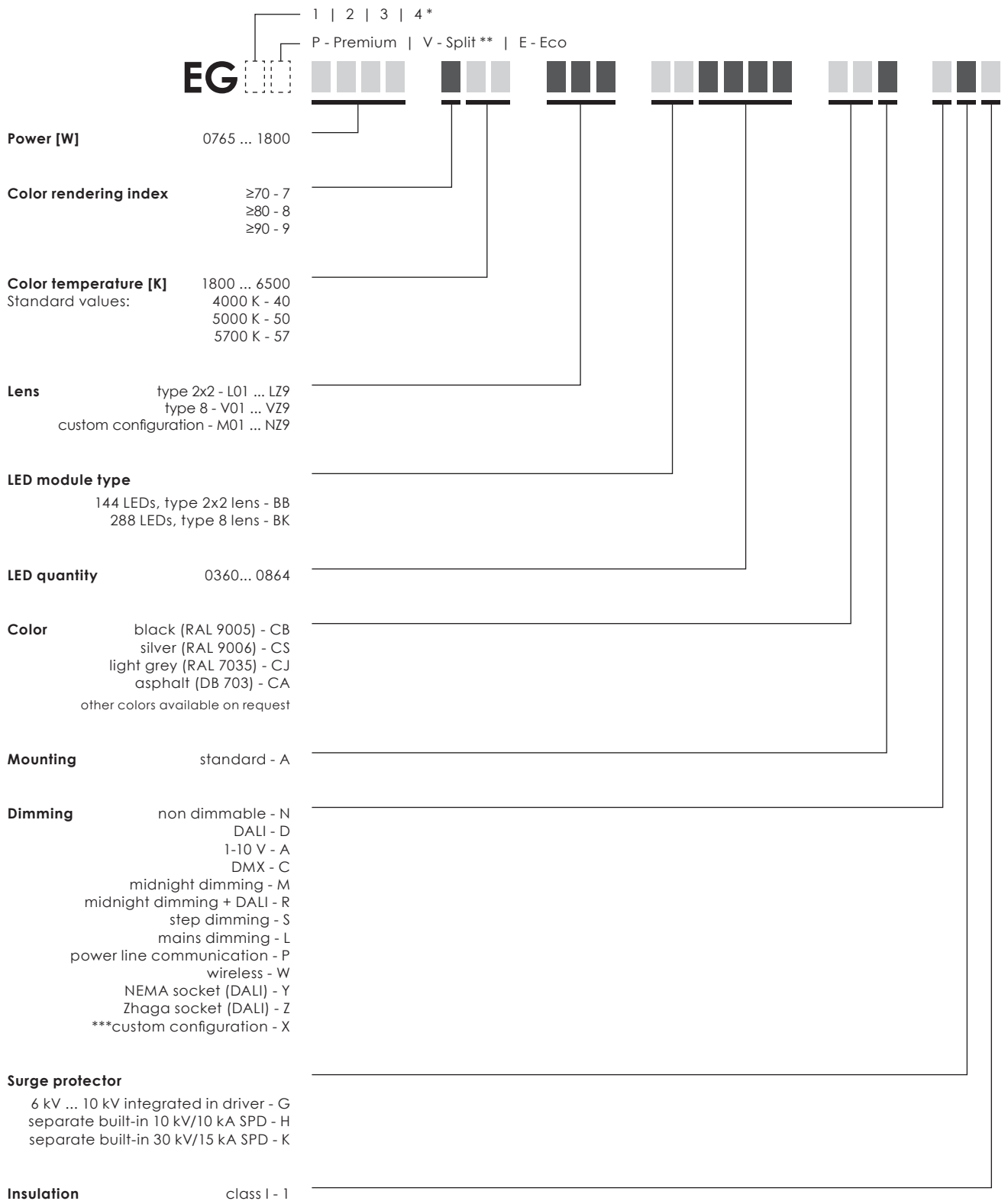

EXAMPLE EG3E 1560 740 L87 B80432 CSA DG1

* Head count

** External driver

*** CUSTOM CONFIGURATION EXAMPLE:

NEMA socket + Zhaga socket; NEMA socket + Zhaga socket + midnight dimming; etc.
Custom configuration information is available in order confirmation.

LED modules

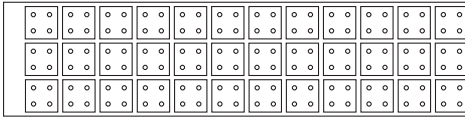
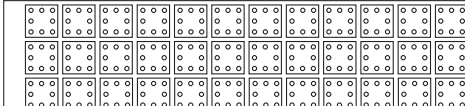
Type	Max module quantity	Min LED quantity per module	Max LED quantity per module	Max LED quantity per luminaire	LED step	LED type	Lens type	Layout
BB	3	120	144	432	-	Eco	type 2x2 L01...LZ9	
BK	3	240	288	864	-	Eco	type 8 V01...VZ9	

Cable core count

Socket	Dimming	Model number abbreviation	Input cable core count - Class I	Input cable core count - Class II
None	None	N	3	2
None	DALI	D	5	4
None	Midnight dimming	M	3	2
None	Midnight dimming + DALI	R	5	4
None	Step dimming	S	5 ⁽¹⁾	4 ⁽¹⁾
None	Mains dimming	L	3	2
Zhaga	DALI	Z	3 ⁽²⁾	2 ⁽²⁾
Zhaga	Midnight dimming	X	3	2
Zhaga	Mains dimming	X	3	2
NEMA	DALI	Y	3 / 5 ⁽³⁾	2 / 4 ⁽³⁾
NEMA	Midnight dimming	X	3	2
NEMA	Step dimming	X	5 ⁽¹⁾	4 ⁽¹⁾
NEMA	Mains dimming	X	3	2

¹⁾ 1 core unused

²⁾ DALI wires used only for internal connection between driver and Zhaga socket(s)

³⁾ +2 cores for external DALI connection

Optics

L15

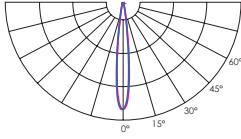

L16

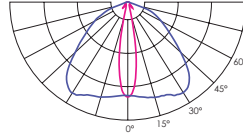

L87

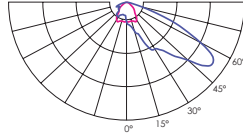

L88

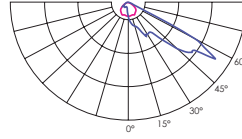

L89

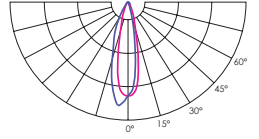

LB6

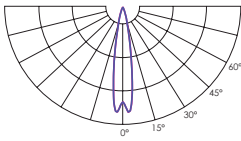

LB8

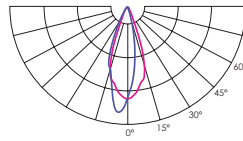

LB9

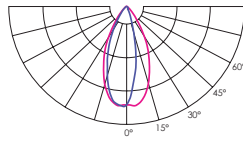

LC1

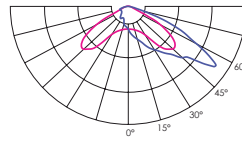

Installation possibilities

Mounting options

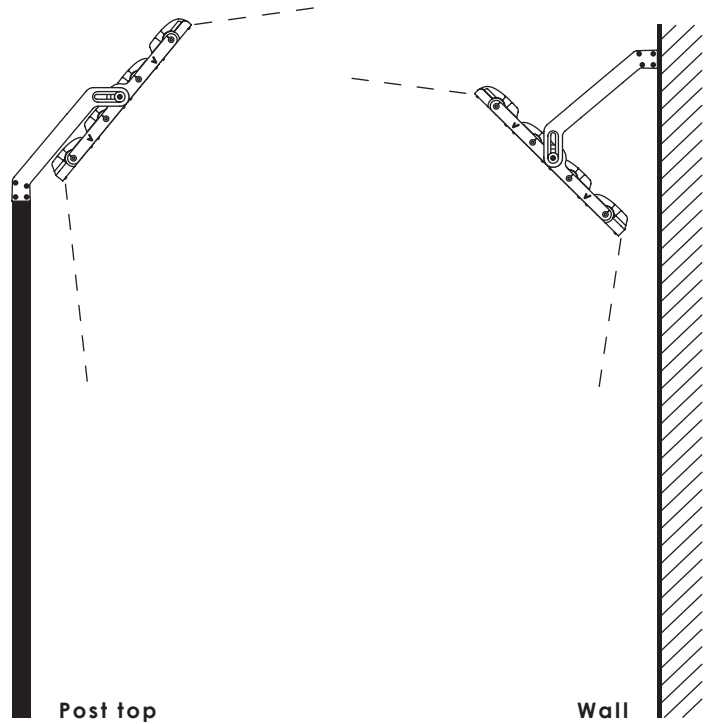
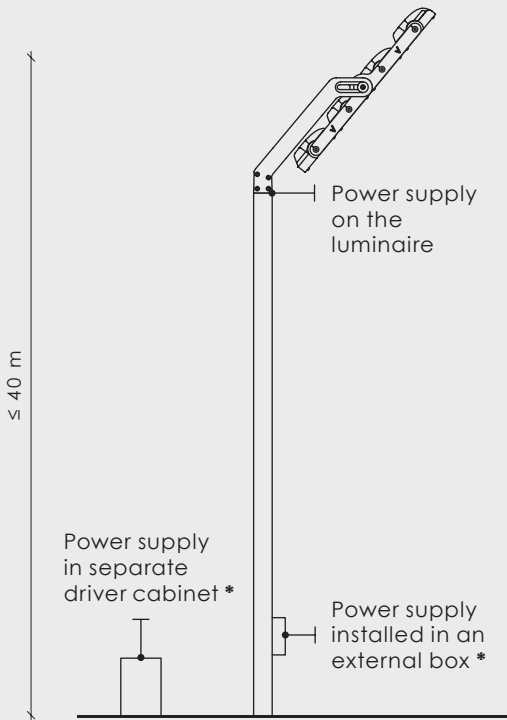

Max. cable length between drivers and luminaire/LED modules: **<200 m****

Min. conductor cross section area: **1.5 mm²**

Cable core quantity:

- 1 head - **3 cores** | x1 cable *
- 2 heads - **5 cores** | x1 cable *
- 3 heads - **7 cores** | x1 cable *
- 4 heads - **5 cores** | x2 cables *

* Luminaire to driver cable must be ordered separately from the accessories list

** For detailed information on specific LED drivers please contact VIZULO sales representative

Surface

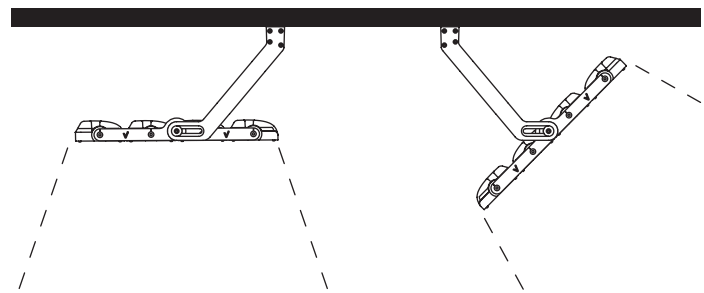

Rotation options

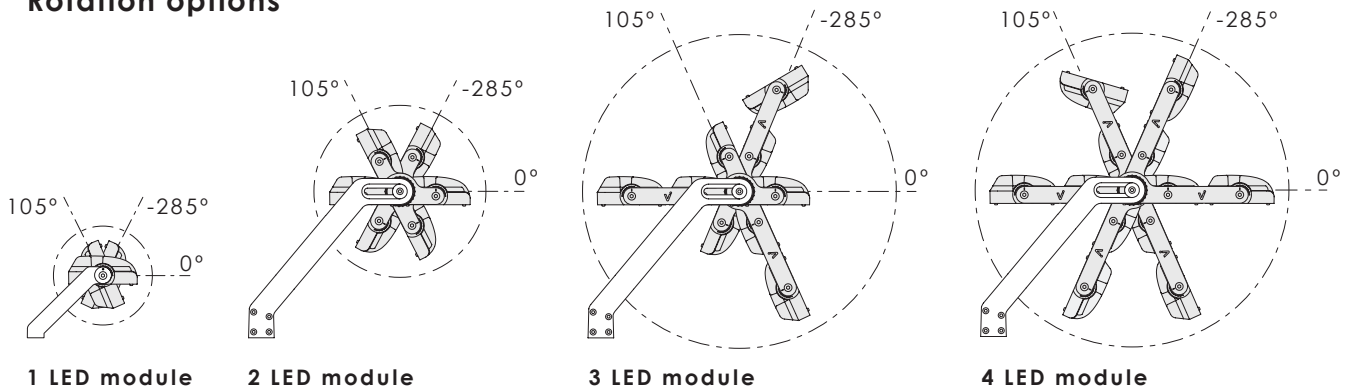

Accessories

Laser pointer with bracket

Art. 70000714

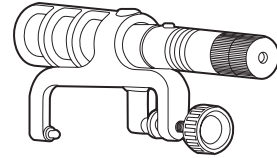

Axis target with bracket

Art. 70000729

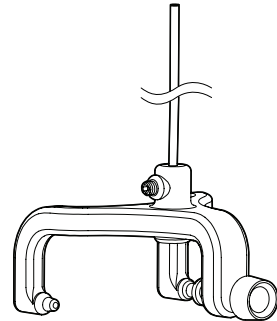

Pre-installed cable sets For internal power supply

3 x 1,5 mm - 0,5 m long cable.....	Art. 70000319
3 x 1,5 mm - 5 m long cable.....	Art. 70000320
3 x 1,5 mm - 6 m long cable.....	Art. 70000321
3 x 1,5 mm - 8 m long cable.....	Art. 70000322
3 x 1,5 mm - 10 m long cable.....	Art. 70000323
3 x 1,5 mm - 12 m long cable.....	Art. 70000324
3 x 1,5 mm - 18 m long cable.....	Art. 70000325
3 x 1,5 mm - 20 m long cable.....	Art. 70000425
3 x 1,5 mm - 22 m long cable.....	Art. 70000426
3 x 1,5 mm - 25 m long cable.....	Art. 70000427
3 x 1,5 mm - 32 m long cable.....	Art. 70000430
3 x 1,5 mm - 42 m long cable.....	Art. 70000431
3 x 1,5 mm - 50 m long cable.....	Art. 70000432

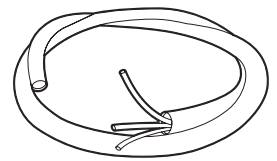

5 x 1,5 mm - 0,5 m long cable.....	Art. 70000305
5 x 1,5 mm - 5 m long cable.....	Art. 70000316
5 x 1,5 mm - 6 m long cable.....	Art. 70000317
5 x 1,5 mm - 8 m long cable.....	Art. 70000318
5 x 1,5 mm - 10 m long cable.....	Art. 70000306
5 x 1,5 mm - 12 m long cable.....	Art. 70000307
5 x 1,5 mm - 18 m long cable.....	Art. 70000308
5 x 1,5 mm - 20 m long cable.....	Art. 70000428
5 x 1,5 mm - 22 m long cable.....	Art. 70000429
5 x 1,5 mm - 25 m long cable.....	Art. 70000429
5 x 1,5 mm - 32 m long cable.....	Art. 70000433
5 x 1,5 mm - 42 m long cable.....	Art. 70000434
5 x 1,5 mm - 50 m long cable.....	Art. 70000435

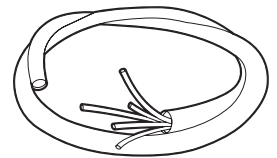

Certification



CE – conformity with European Union's health, safety and environmental protection standards

The CE mark is placed on products to state conformity with the relevant EU health, safety and environmental protection standards. In case of electronic products, the standards are, for example, the Restriction of Hazardous Substances in Electrical and Electronic Equipment (RoHS) directive, Waste Electrical and Electronic Equipment (WEEE) directive, the Electromagnetic Compatibility (EMC) directive etc. The mark ensures that the product can be sold anywhere in the European Economic Area (EEA).



UKCA - conformity with the relevant essential requirements of Great Britain

UKCA is a product mark intended to demonstrate compliance with the directives set by Great Britain (England, Scotland and Wales). It is analogous to the European Union's CE marking, meaning that depending on the type of product the applicable regulations are different. In case of LED lighting, the relevant requirements are compliance with the Electromagnetic Compatibility Regulations, the Electrical Equipment (Safety) Regulations, the Restriction of the Use of Certain Hazardous Substances in Electrical and Electronic Equipment Regulations and the Ecodesign for Energy-Related Products and Energy Information (Lighting Products) Regulations.



RoHS – compliance with European Union's RoHS directive

The RoHS (Restriction of Hazardous Substances in Electrical and Electronic Equipment) directive restricts (with exceptions) the use of ten hazardous materials in the manufacture of various types of electronic and electrical equipment. The aim of the directive is to prevent the risks posed to human health and the environment related to the management of electronic and electrical waste.



Ball-proof – compliance with the requirements of the DIN 57710-13 testing standard

The ball-proof test is described in the standard DIN 57710-13 (Luminaires with operating voltages below 1000 V; luminaires safety to ball throwing). The standard defines the requirements set for impact resistance of luminaires meant for use in indoor sports facilities. It states that a luminaire struck by a ball must withstand any damage that could cause parts of the luminaire to fall to the ground.



UL - compliance with UL standards for LED lighting

UL stands for Underwriter Laboratories, a third-party certification company that's been around for over a century. UL sets industry-wide standards for products and performs testing according to these standards to ensure that the products marked with the UL mark are safe and high quality.



Zhaga-D4i - compliance with the requirements of Zhaga Book 18 or 20 and DALI standard

The Zhaga-D4i Mark represents the fact that a product is certified following the Zhaga-D4i joint certification program – a program established by Zhaga and the DALI Alliance (DiiA). The Zhaga part of the Mark represents that a product meets the requirements of Zhaga Book 18 or 20 – Zhaga standards that describe a smart interface between outdoor luminaires and sensing/ communication nodes. The DALI Alliance part of the Mark signifies that the product conforms with the DALI standard for intelligent, IoT-ready luminaires.



ENEC - compliance with European standards for electrical equipment

The ENEC Mark is the high quality European Mark for electrical equipment. It is governed by the European Testing Inspection Certification System which ensures that the testing of products is conducted at ENEC – accredited laboratories, following additional requirements regarding the testing procedures. The ENEC Mark means that the testing procedure was followed scrupulously and that the consumer can be certain of the product's safety and quality.



International EPD System – Environmental Product Declaration available

An Environmental Product Declaration (EPD) is a declaration of the materials, energy, transportation and other resources involved in the production, use and end-of life of a specific product. It is based on a Life Cycle Assessment (LCA) study that complies with standards EN ISO 14040 and EN ISO 14044. A product's EPD can help evaluate its impact on the environment and make sustainable choices.



LED module replaceable by a professional

This pictogram shows that the LED modules included in the luminaire are only replaceable by a professional. This labeling is a requirement following the introduction of European Union's Regulation on energy labelling for light sources (EU) 2019/2015.

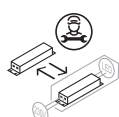

LED driver replaceable by a professional

This pictogram shows that the LED driver included in the luminaire is only replaceable by a professional. This labeling is a requirement following the introduction of European Union's Regulation on energy labelling for light sources (EU) 2019/2015.

References



↘
Stade Mathieu Bodmer,
Evreux, France



↘
Beynes,
France



VIZULO

Bukultu street 11
Riga, LV – 1005, Latvia

Sales: + 371 67 383 023
Production: + 371 67 383 024

sales@vizulo.com
www.vizulo.com

